



OLYMPIA

1375.40LG/OiG

DESIGN

Rotisol's traditional rustic-style rotisserie, the OLYMPIA, is an attractive show-piece for any restaurant or kitchen and is used by chefs in Michelin's star restaurants around the world.

The naked flame from Rotisol's patented burners lick the cast iron hearth and porcelain wicks creating a spectacular visual that can be seen through the front and side glass doors.

Spits are driven by an elegant system of chains and pulleys, rotating at 2 ½ times per minute ensuring perfectly cooked, self-basting poultry, meat, vegetables and fish.

FEATURES

- Rotisol patented burners.
- 4 tempered glass doors.
- Protective roof included.
- Equipped with bottom drip tray with drainage tap.
- Pre-installed vertical spit system.
- Powerful halogen lamp.

FINISHES

Standard model in black enamel. A choice of other colours are available.











With chrome or brass trims.



ACCESSORIES

A variety of accessories are available for the unit. Video of available [accessories](#) and video of [vertical spit system](#).

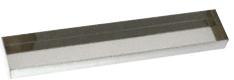
| | | |
|--|--|---|
| CUI13 Anti-cutting prongless spit.  | BP13 Chicken spit.  | BRC13 Basket spit.  |
| BS13 Sabre spit for ham / turkey.  | BRRO13 Roast-clamp spit.  | BA13 Lamb/suckling-pig spit.  |
| GCP13 Spare rib rack.  | GSV13 Raised rack for meat storage.  | PID13 Stainless steel tray to unspit.  |



1375.40LG

Black and brass finish



Front view
Rotisserie with roof
and base on casters (optional)

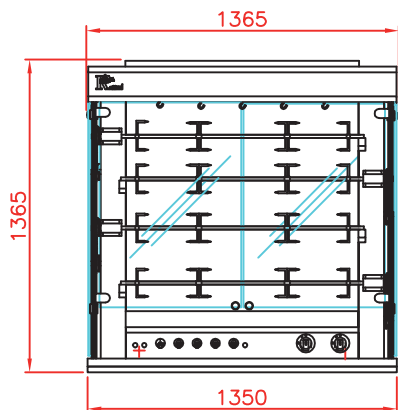

Side view
Rotisserie with roof
and base on casters (optional)

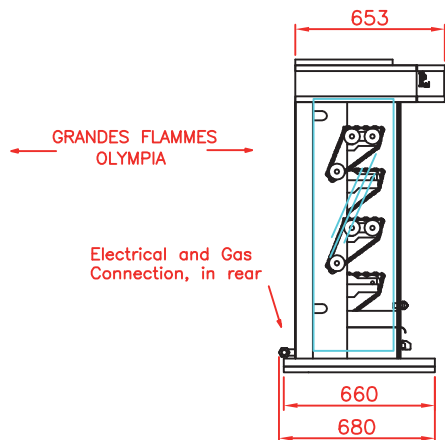

Top view
Rotisserie with roof
and base on casters (optional)

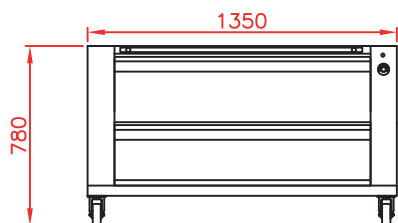
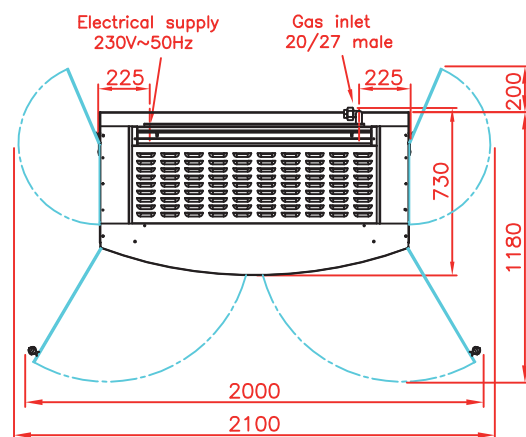

Heated base cabinet
with drawers
(Optional)

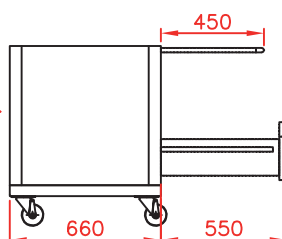

1375.40iG

Stainless steel finish



SPECIFICATIONS

| | |
|--------------------------|--|
| Gas Power | 30 kW |
| Gas consumption | Natural gas : 3.18 m ³ /h ; Propane : 2.32 kg/h |
| Gas connection | 20/27 male |
| Electricity | 230 V 50/60 Hz + earth 0.67 kW |
| Capacity | 20/24 poultries (depending on size) |
| Warranty | 1 year on parts (excluding glass doors) |
| Extraction | Compulsory |
| Minimum clearance | 39 cm on the left and right, 22 cm at the rear |
| Weight | 250 kg without packing |

Revised : December 2013

DISTRIBUTOR / AGENT

Rotisol S.A.S.

Zone industrielle La Trentaine, Avenue Gustave Eiffel

77507 Chelles cedex - FRANCE

bennell@rotisol.com - Tel : +33 1 64 21 80 00

www.rotisol.com