

# Performances

## 1160.6PAE/PAiE

### DESIGN

The Performances range of rotisseries has been especially designed for high-volume cooking with high output and speed, while retaining excellent cooking quality. Well designed, user friendly and reliable the Performances is used by leading super-markets and chain restaurants throughout the world.

Conscious of the high energy cost involved for our clients, the Performances rotisserie has energy saving infrared burners, patented by Rotisol. A wide array of accessories enable the rapid roasting of a variety of products.

### FEATURES

- Energy efficient
- Tempered K-glass doors
- Independent motor for each spit
- Equipped with bottom drip tray with built-in drainage
- Reinforced and anti warping heating element
- Powerful halogen lamp
- Delivered with 6 prongless spits (BCR1160)
- Illuminated sign «Rotisserie»
- Base on casters with brakes







1160.6PAE  
Black enamel

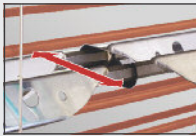
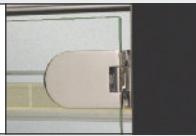
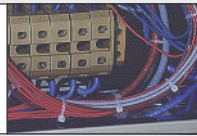

### TECHNICAL DETAILS

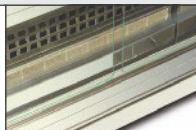
Overview of some of the standard features.

	Independent motors adjustable in depth for each spit		Robust hinges designed for heavy use, with integrated locking in open and closed positions		Easy and protected access to the compartment of connections and electrical components.
	Reinforced heating elements with stainless steel holders to keep them in place and removable stainless steel panels for easy cleaning.		Anti-scald K-glass reduces external thermal radiation (energy saving). Glass overlaps drip pan to keep splatters inside (anti-slip protection).		Removable inside side-panels doubles protection from grease seeping into motors and other sensitive parts

### ACCESSORIES

A variety of accessories are available. See video of available [accessories](#) and of [vertical spit system](#) online.

<b>CUI1160</b> Anti-cutting prongless V-spit.		<b>PID1160</b> Tray for unspitting.		<b>BRC1160</b> Rectangular basket spit.	
<b>BS1160</b> Spit for ham / turkey.		<b>BRRO1160</b> Roast-clamp spit.		<b>BA1160</b> Lamb/suckling-pig spit.	
<b>BCR1160</b> Spatchcock chicken basket.		<b>DEC</b> Spit mover.		<b>AT</b> Gas lighter.	

### Front view

Rotisserie with roof (optional)  
and base on casters (optional)

### Side view

Rotisserie with roof (optional)  
and base on casters (optional)

### Top view

Rotisserie with roof (optional)  
and base on casters (optional)

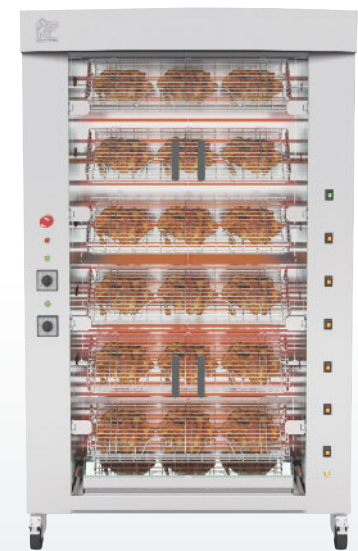
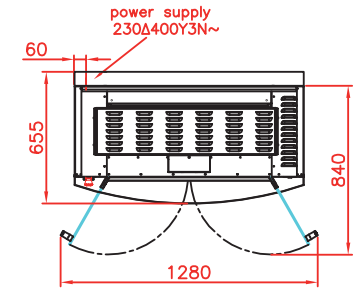
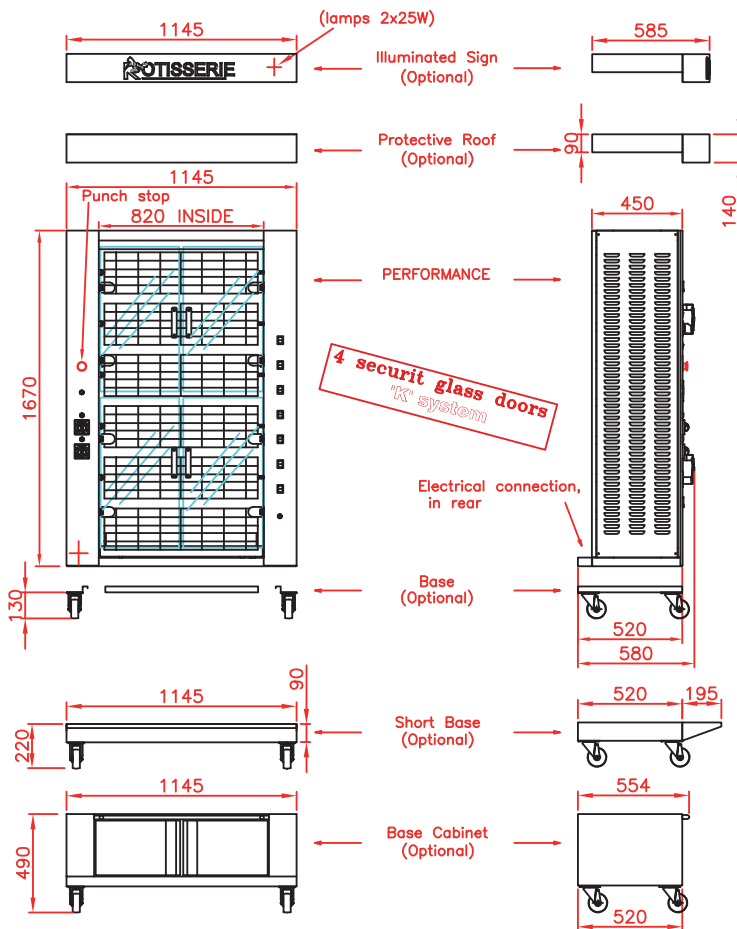

1160.6PAiE  
Stainless steel



Revised :  
April 2019



## SPECIFICATIONS

Capacity	24/30 poultries ; 18/24 open poultries
Power supply	400 Volts 3 phases+neutral+earth
Electrical power	21.4 kW
Weight and size (HxDxW)	160 kg ; 1890 x 655 x 1145 mm
Shipping weight and size	220 kg ; 2000 x 750 x 1210 mm
Guarantee	1 year parts

DISTRIBUTOR / AGENT

Rotisol S.A.S.

Zone industrielle La Trentaine, Avenue Gustave Eiffel

77507 Chelles cedex - FRANCE

[s.bennell@rotisol.com](mailto:s.bennell@rotisol.com) - Tel : +33 1 64 21 80 00

[www.rotisol.com](http://www.rotisol.com)