

Special Market

1425.4SMAE/SMAiE

DESIGN

The Special Market range of rotisseries has been designed with performance, practicality and mobility in mind. Light weight and compact Special Market is the ideal rotisserie for markets and food trucks and offers rapid production together with excellent cooking quality.

Conscious of the costs involved for our clients, the Special Market rotisserie has energy-saving infrared burners, patented by Rotisol, that enable the rapid roasting of a variety of products.

FEATURES

- Energy efficient
- 2 Tempered K-glass doors (removable for transport)
- Independent motor for each spit
- Spits with Bakelite handles
- Equipped with bottom drip tray with built-in drainage
- Reinforced and anti warping heating element
- Optional lighting
- Delivered with 4 spits (BCR1425)
- Base on casters with brakes







1425.4SMAE

Black front panels and stainless steel finish



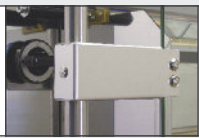
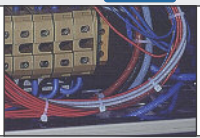





TECHNICAL DETAILS

Overview of some of the standard features.

	<p>Reinforced heating elements with stainless steel holders to keep them in place and removable stainless steel panels for easy cleaning.</p>		<p>Robust hinges designed for heavy use, with integrated locking in open and closed positions.</p>		<p>Easy and protected access to the compartment of connections and electrical components.</p>
	<p>Independent floating, swinging and adjustable motors to for easy placement and removal of spits.</p>		<p>Anti-scald K-glass reduces external thermal radiation (energy saving). Glass overlaps drip pan to keep splatters inside (anti-slip protection).</p>		<p>Removable inside side-panels doubles protection from grease seeping into motors and other sensitive parts.</p>

ACCESSORIES

A variety of accessories are available. See video of available [accessories](#) online.

<p>CUI1425 Anti-cutting prongless V-spit.</p>		<p>PID1425 Tray for unspitting.</p>		<p>BRC1425 Rectangular basket spit.</p>	
<p>BS1425 Spit for ham / turkey.</p>		<p>BRRO1425 Roast-clamp spit.</p>		<p>BA1425 Lamb/suckling-pig spit.</p>	
<p>BCR1425 Spatchcock chicken basket.</p>		<p>DEC Spit mover.</p>		<p>AT Gas lighter.</p>	

Front view

Rotisserie with roof (optional)
and base on casters (optional)

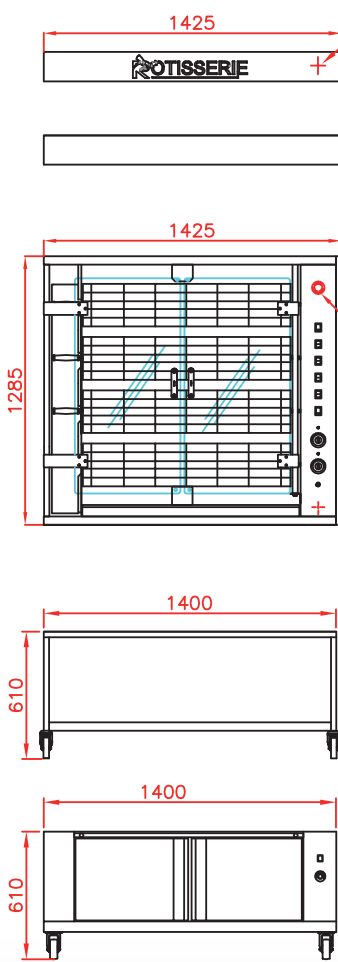

Side view

Rotisserie with roof (optional)
and base on casters (optional)

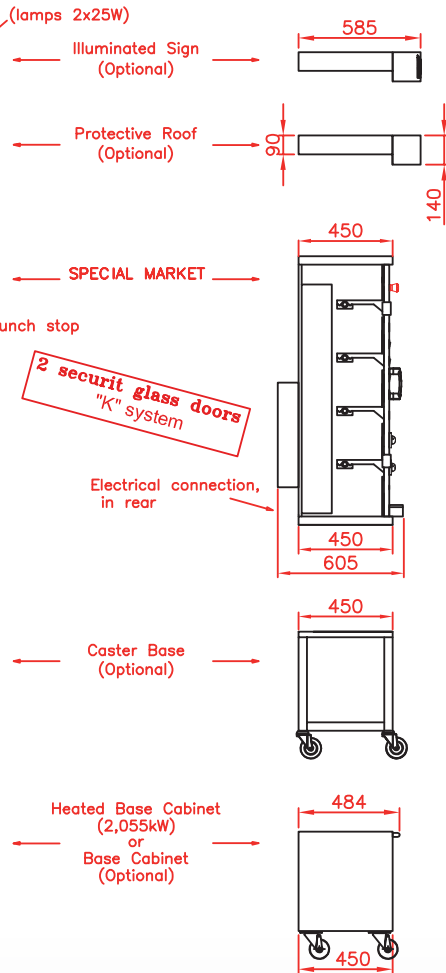

Top view

Rotisserie with roof (optional)
and base on casters (optional)

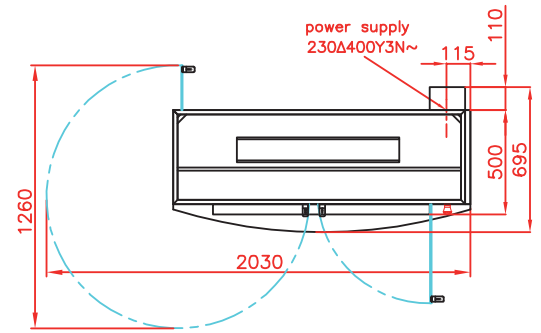

1425.4SMAiE
Stainless steel finish



Revised :
April 2019

SPECIFICATIONS

Capacity	20/24 poultries ; 16/20 open poultries
Power supply	400 Volts 3 phases+neutral+earth
Electrical power	29.92 kW
Weight and size (HxDxW)	170 kg ; 1985 x 695 x 1425 mm
Shipping weight and size	230 kg ; 1950 x 760 x 1450 mm
Guarantee	1 year parts



DISTRIBUTOR / AGENT

Rotisol S.A.S.

Zone industrielle La Trentaine, Avenue Gustave Eiffel

77507 Chelles cedex - FRANCE

s.bennell@rotisol.com - Tel : +33 1 64 21 80 00

www.rotisol.com