



FauxFlame™ FF1425-8G



DESIGN

The FAUXFLAME range of rotisseries has been designed with performance, practicality and mobility in mind. Light weight and compact FAUXFLAME is the ideal rotisserie for markets and food trucks and offers rapid production together with excellent cooking quality.

Conscious of the costs involved for our clients, the FAUXFLAME rotisserie has energy-saving infrared burners, patented by Rotisol, that enable the rapid roasting of a variety of products.

FEATURES

- Independent motor for each spit
- Spits with Bakelite handles
- Independent infrared gas burners with interchangeable ceramic bricks
- 2 K-glass doors (removable for transport)
- Bottom drip tray with drainage tap
- Optional lighting

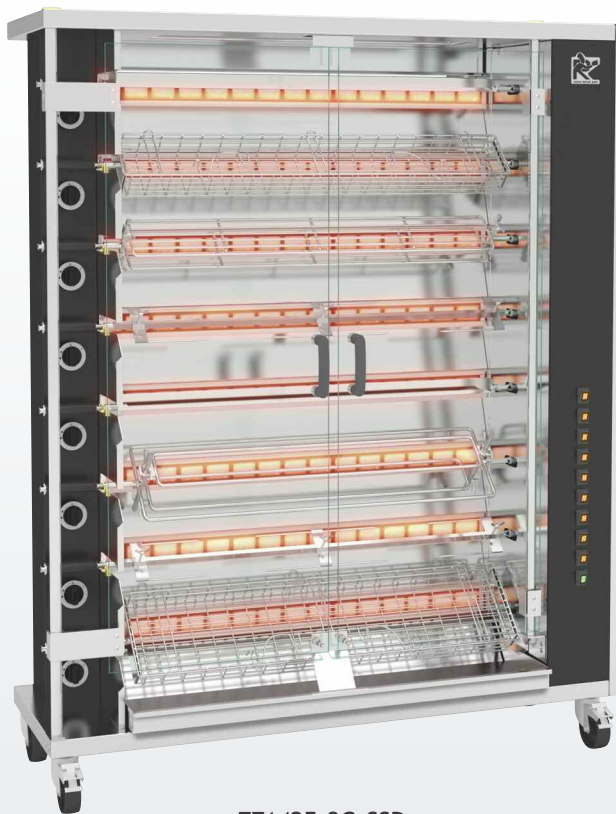

FF1425-8G-SSP
Black enamel

TECHNICAL DETAILS

Overview of some of the standard features.

	<p>Replaceable ceramic bricks for significant financial savings.</p>		<p>Robust hinges designed for heavy use, with integrated locking in open and closed positions.</p>		<p>Gas safety ! separation of the gas and electric chambers avoids any risks of explosion.</p>
	<p>Independent floating, swinging and adjustable motors to for easy placement and removal of spits.</p>		<p>Anti-scald K-glass reduces external thermal radiation (energy saving). Glass overlaps drip pan to keep splatters inside (anti-slip protection).</p>		<p>Removable inside side-panels doubles protection from grease seeping into motors and other sensitive parts</p>

ACCESSORIES

A variety of accessories are available. See video of available accessories online.

<p>CUI1425 Anti-cutting prongless V-spit.</p>		<p>BPOR1425 Porchetta spit.</p>		<p>BRC1425 Rectangular basket spit.</p>	
<p>BS1425 Spit for ham / turkey.</p>		<p>BRRO1425 Roast-clamp spit.</p>		<p>BA1425 Lamb/suckling-pig spit.</p>	
<p>BCR1425 Spatchcock chicken basket.</p>		<p>DEC Spit mover.</p>		<p>PID1425 Tray for unspitting.</p>	

Front view

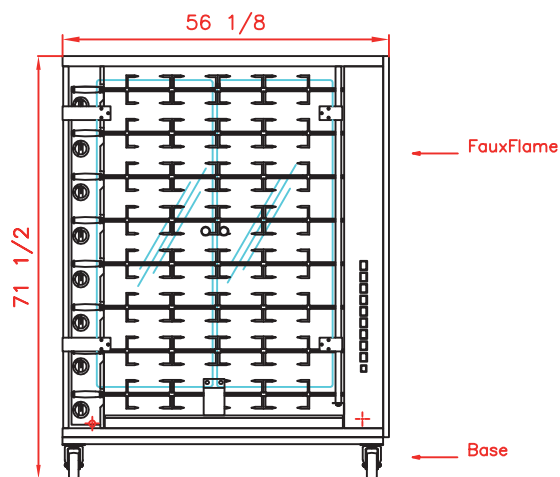

Top view

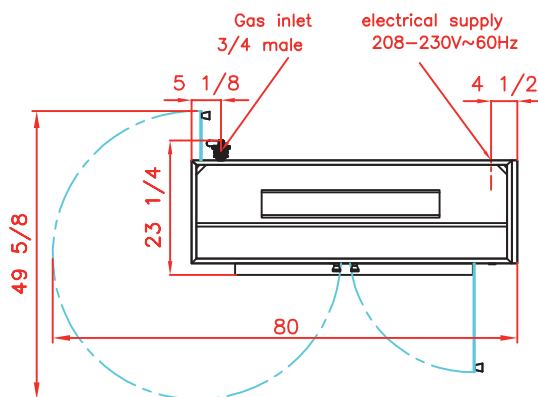

Side view

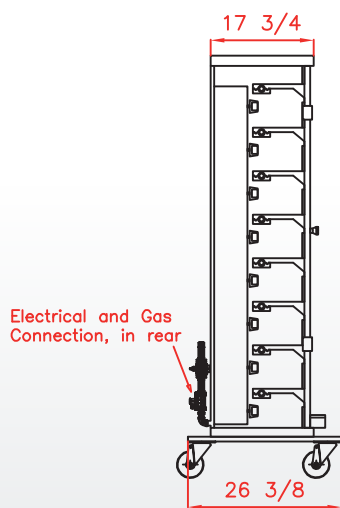

Revised :
December 2016



FF1425-8G-SS
All stainless steel

SPECIFICATIONS

Capacity	40/48 chickens
Gas power	121000 BTU/h
Power supply	208-230V-60Hz ; 3 Amps
Electrical power	0,59 kW
Weight and size (HxDxW)	495 Lbs ; 71 1/2 x 23 1/4 x 56 1/8 inches
Shipping weight and size	640 Lbs ; 76 7/8 x 30 x 57 1/8 inches
Warranty	1 year parts and labor

DISTRIBUTOR / AGENT

Rotisol France, Inc.
415 W. Walnut St. Gardena, CA 90248
info@rotisolusa.com
Ph: 310 671 7254
Fax: 310 671 8071