

Rotisol RÔTISSERIE

MasterFlame™ MF975-4G

DESIGN

Rotisol's traditional rustic-style rotisserie, the MasterFlame, is an attractive show-piece for any restaurant or kitchen and is used by chefs in Michelin's star restaurants around the world.

The visible flames from Rotisol's patented burners spread up the porcelain wicks creating a spectacular visual that can be seen through the front and side glass doors.

Spits are driven by an elegant system of chains and pulleys, rotating at 2 ½ times per minute, ensuring perfectly cooked, self-basting poultry, meat, vegetables and fish.

The optional Vertical Spit System with its choice of eight hanging accessories expands the menu possibilities even more and adds additional visual appeal.

FEATURES

- Rotisol patented burners
- Tempered K-glass front and side doors
- Decorative roof included
- Pre-installed vertical spit system
- Independent motor for each spit
- Equipped with bottom drip tray with built-in drainage
- Powerful halogen lamps
- Delivered with 4 prongless spits (CUI9)







MF975-4G-LUX

Black porcelain enamel and brass



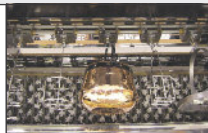
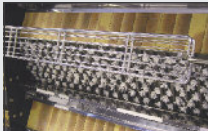

TECHNICAL DETAILS

Overview of some of the standard features.

	Cast iron with ceramic wicks provides a magnificent display of flames		Visible rustic pulleys and drive chains for added front-of-house appeal		Pre-installed vertical spit system allows for vertical cooking
	Decorative terracotta firebricks absorb and radiate the heat		Gas knobs in brass or chrome finish allow fine tuning of the gas flow		Middle drip pan allows separation of products to prevent cross-contamination

ACCESSORIES

A wide variety of accessories are available. Please consult us. See video of available accessories and of vertical spit system online.

CUI9 Anti-cutting prongless V-spit.		BP9 Chicken spit.		BRC9 Rectangular basket spit.	
BS9 Spit for ham / turkey.		BRRO9 Roast-clamp spit.		BA9 Lamb/suckling-pig spit.	
BCR9 Spatchcock chicken basket.		DEC Spit mover.		BPOR9 Porchetta spit.	

Front view
Rotisserie with roof

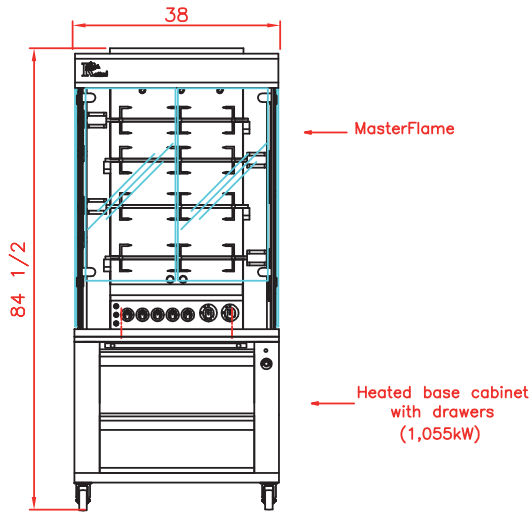

Top view
Rotisserie with roof

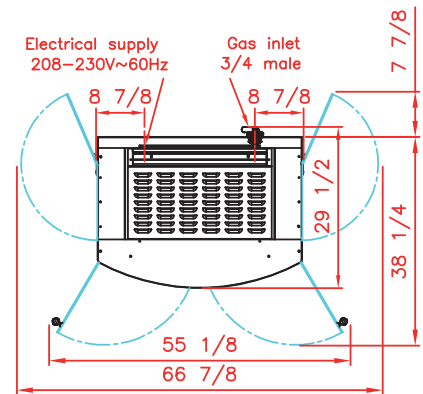

Side view
Rotisserie with roof

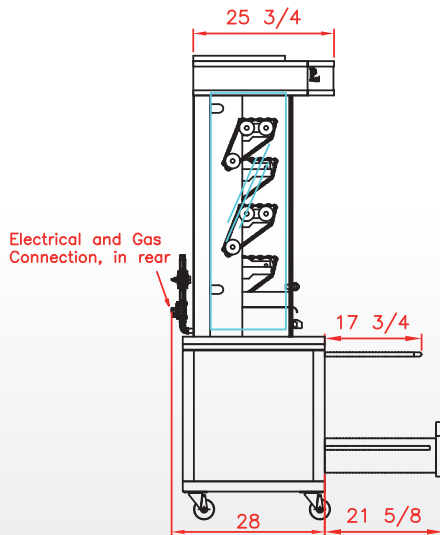

Revised :
December 2017



MF975-4G-LUX
Black porcelain enamel with chrome

DISTRIBUTOR / AGENT

SPECIFICATIONS

Capacity	8/12 poultries
Gas power	55000 BTU/h
Power supply	208-230V-60Hz ; 2,1 Amps
Electrical power	0,42 kW
Weight and size (HxDxW)	445 Lbs ; 84 1/2 x 29 1/2 x 38
Shipping weight and size	664 Lbs ; 87 1/2 x 30 x 42 1/8
Warranty	1 year parts and labor

Rotisol France, Inc.
415 W. Walnut St. Gardena, CA 90248
info@rotisolusa.com
Ph :310 671 7254
Fax :310 671 8071