

### FauxFlame™ FF1175-8E



#### DESIGN

The FAUXFLAME range of rotisseries has been designed with performance, practicality and mobility in mind. Light weight and compact FAUXFLAME is the ideal rotisserie for markets and food trucks and offers rapid production together with excellent cooking quality.

Conscious of the costs involved for our clients, the FAUXFLAME rotisserie has energy-saving infrared burners, patented by Rotisol, that enable the rapid roasting of a variety of products.

#### FEATURES

- Independent motor for each spit
- Spits with Bakelite handles
- Reinforced and anti warping heating element
- 2 K-glass doors (removable for transport)
- Bottom drip tray with drainage tap
- Optional lighting

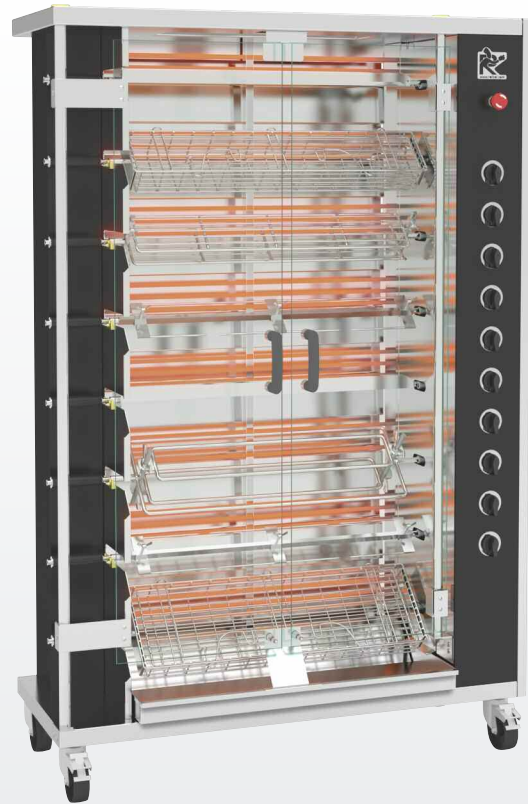

FF1175-8E-SSP  
Black enamel

#### TECHNICAL DETAILS

Overview of some of the standard features.



Reinforced heating elements with stainless steel holders to keep them in place and removable stainless steel panels for easy cleaning.

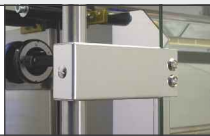

Robust hinges designed for heavy use, with integrated locking in open and closed positions.



Easy and protected access to the compartment of connections and electrical components.



Independent floating, swinging and adjustable motors to for easy placement and removal of spits.





Anti-scald K-glass reduces external thermal radiation (energy saving). Glass overlaps drip pan to keep splatters inside (anti-slip protection).



Removable inside side-panels doubles protection from grease seeping into motors and other sensitive parts

#### ACCESSORIES

A variety of accessories are available. See video of available accessories online.

<b>CUI1175</b> Anti-cutting prongless V-spit.		<b>BPOR1175</b> Porchetta spit.		<b>BRC1175</b> Rectangular basket spit.	
<b>BS1175</b> Spit for ham / turkey.		<b>BRRO1175</b> Roast-clamp spit.		<b>BA1175</b> Lamb/suckling-pig spit.	
<b>BCR1175</b> Spatchcock chicken basket.		<b>DEC</b> Spit mover.		<b>PID1175</b> Tray for unspitting.	

Front view

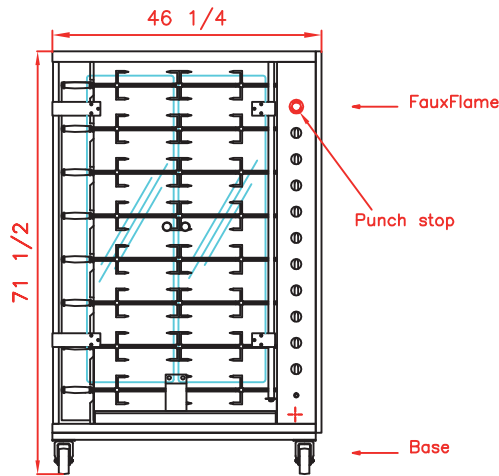

Top view

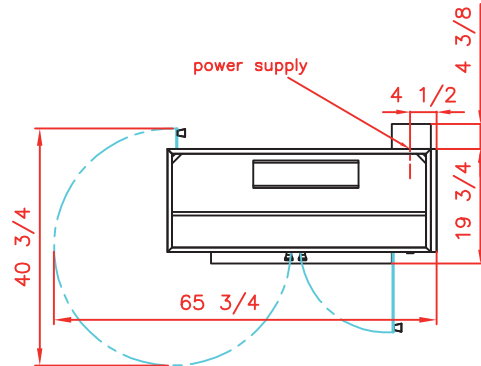

Side view

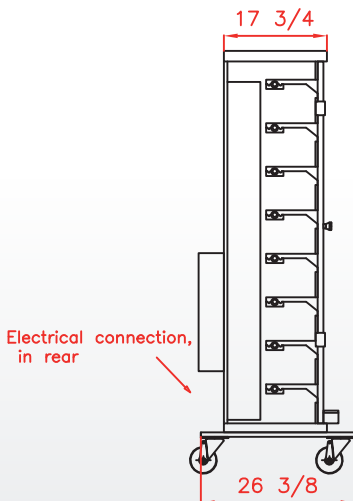

Revised :  
December 2016



FF1175-8E-SS  
All stainless steel

## SPECIFICATIONS

Capacity	32/40 chickens
Power supply	208-240V-60Hz ; 71 Amps
Electrical power	25,59 kW
Weight and size (HxDxW)	395 Lbs ; 71 1/2 x 24 x 46 1/4 inches
Shipping weight and size	530 Lbs ; 78 3/4 x 30 x 47 5/8 inches
Warranty	1 year parts and labor

DISTRIBUTOR / AGENT

Rotisol France, Inc.  
415 W. Walnut St. Gardena, CA 90248  
[info@rotisolusa.com](mailto:info@rotisolusa.com)  
Ph: 310 671 7254  
Fax: 310 671 8071