

### FauxFlame™ FFS1100-4G

#### DESIGN

The Brasilia rotisserie line is dedicated to the unique spatchcock style cooking method, roasting whole butterflied chickens flavored with any choice of marinades or seasonings.

Spatchcock roasting is a perfect fit for any kind of ethnic market (Hispanic, Middle Eastern, etc.), while doubling your production volume and decreasing your energy consumption by half.

#### FEATURES

- All stainless steel unit
- Front and back visibility and accessibility
- Independent infrared gas burners with interchangeable ceramic bricks
- 4 K-glass doors
- Bottom drip tray with drainage tap
- Interior halogen lighting

#### BRASILIA

- 27 chickens in 30 minutes
- Reduced gas consumption 9 spits = 41000 (btu/h)
- Compact design with optimized dimensions (shallow depth: 21 1/8")
- Quick return on investment



FFS1100-4G

All stainless steel

#### TECHNICAL DETAILS

Overview of some of the standard features.

	<p>Replaceable ceramic bricks for significant financial savings.</p>		<p>Bottom drip tray with drainage tap.</p>		<p>Gas safety ! separation of the gas and electric chambers avoids any risks of explosion.</p>
	<p>Interior halogen lighting.</p>		<p>Anti-scald K-glass reduces external thermal radiation (energy saving). Glass overlaps drip pan to keep splatters inside (anti-slip protection).</p>		<p>Support bar for support of spit in open position, during the loading and unloading of chickens from the rotisserie.</p>

#### ACCESSORIES

A variety of accessories are available. See video of available accessories system online.

<p>BCRBRASIL Spatchcock chicken basket.</p>		<p>DEC Spit mover.</p>		<p>AT Gas lighter.</p>	
---	---	----------------------------	--	----------------------------	---

Front view

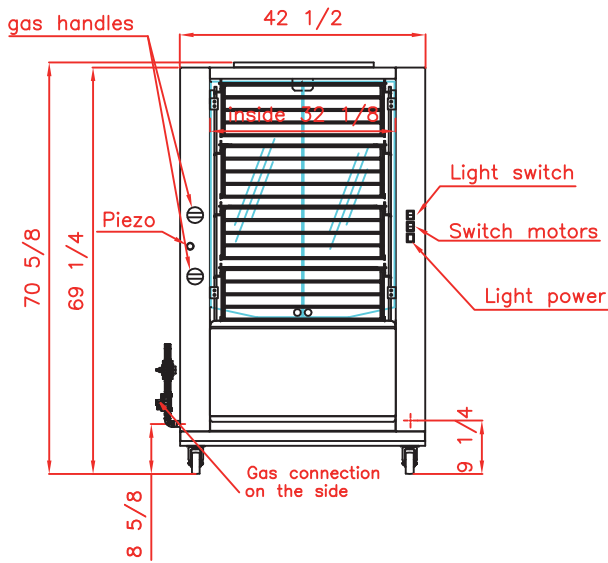

Top view

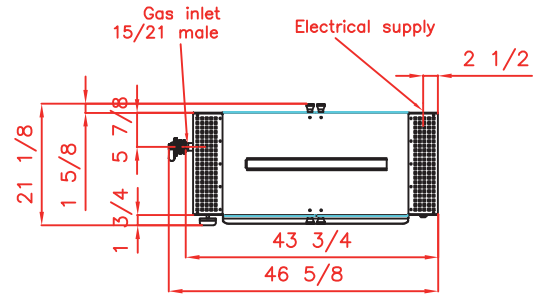

Side view

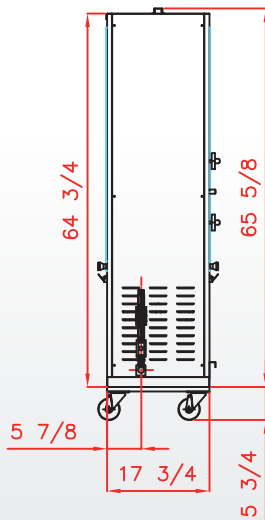

Revised :  
September 2018



FFS1100-4G  
All stainless steel

## SPECIFICATIONS

Capacity	27 chickens
Gas power	41000 BTU/h
Power supply	208-240V-60Hz ; 1,1 Amps
Electrical power	0,23 kW
Weight and size (HxDxW)	430 Lbs ; 70 5/8 x 21 1/8 x 46 5/8 inches
Shipping weight and size	552 Lbs ; 77 3/8 x 30 x 48 1/4 inches
Warranty	1 year parts and labor

DISTRIBUTOR / AGENT

Rotisol France, Inc.  
415 W. Walnut St. Gardena, CA 90248  
[info@rotisolusa.com](mailto:info@rotisolusa.com)  
Ph: 310 671 7254  
Fax: 310 671 8071