

FlamBoyant™ FB1400-4E

DESIGN

The FlamBoyant range of rotisseries has been especially designed for high-volume cooking with high output and speed, while retaining excellent cooking quality. Well designed, user friendly and reliable the FlamBoyant is used by leading supermarkets and chain restaurants throughout the world.

Conscious of the high energy cost involved for our clients, the FlamBoyant rotisserie has energy saving infrared burners, patented by Rotisol. A wide array of accessories enable the rapid roasting of a variety of products.

FEATURES

- Energy efficient
- Tempered K-glass doors
- Independent motor for each spit
- Equipped with bottom drip tray with built-in drainage
- Reinforced and anti warping heating element
- Powerful halogen lamp
- Delivered with 4 prongless spits (CUI1375-1400)
- Illuminated sign «Rotisserie» for enamel model only
- Base on casters with brakes



FB1400-4E-SSP
Black enamel

TECHNICAL DETAILS

Overview of some of the standard features.

	Independent motors adjustable in depth for each spit.		Robust hinges designed for heavy use, with integrated locking in open and closed positions.		Easy and protected access to the compartment of connections and electrical components.
	Reinforced heating elements with stainless steel holders to keep them in place and removable stainless steel panels for easy cleaning.		Anti-scald K-glass reduces external thermal radiation (energy saving). Glass overlaps drip pan to keep splatters inside (anti-slip protection).		Removable inside side-panels doubles protection from grease seeping into motors and other sensitive parts.

ACCESSORIES

A variety of accessories are available. See video of available accessories and of vertical spit system online.

CUI1375-1400 Anti-cutting prongless V-spit.		BP1375-1400 Porchetta spit.		BRC1375-1400 Rectangular basket spit.	
BS1375-1400 Spit for ham / turkey.		BRRO1375-1400 Roast-clamp spit.		BA1375-1400 Lamb/suckling-pig spit.	
BCR1375-1400 Spatchcock chicken basket.		DEC Spit mover.		PID1375-1400 Tray for unspitting.	

Front view
Rotisserie with roof

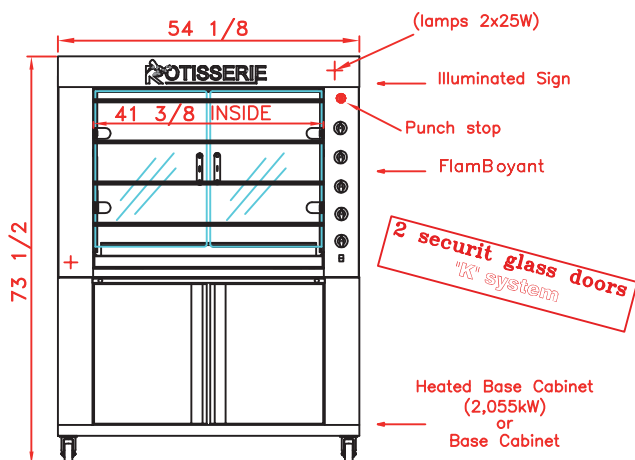

Top view
Rotisserie with roof

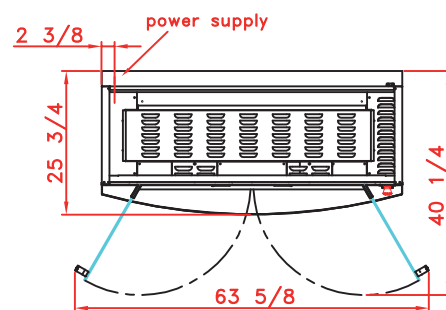

Side view
Rotisserie with roof

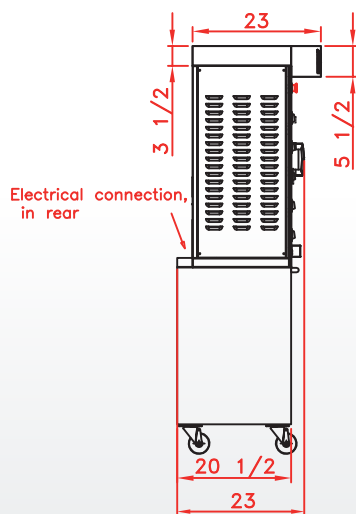

Revised :
October 2020



FB1400-4E-SS
Stainless steel

SPECIFICATIONS

Capacity	20/24 chickens
Power supply	208-240V-60Hz ; 51,13 Amps
Electrical power	20,45 kW
Weight and size (HxDxW)	455 Lbs ; 73 1/2 x 25 3/4 x 54 1/8 inches
Shipping weight and size	589 Lbs ; 74 7/8 x 30 3/8 x 58 1/4 inches
Warranty	1 year parts and labor

DISTRIBUTOR / AGENT

Rotisol France, Inc.
415 W. Walnut St. Gardena, CA 90248
info@rotisolusa.com
Ph :310 671 7254
Fax :310 671 8071