

## DESIGN

Rotisol's most popular line, the GrandFlame combines the drama of visible flames and the beauty of elegant finishes with the highest degree of functionality.

A wide array of spits allow the chef to cook anything that can be roasted: whole or split chickens, lamb, beef roasts and steaks, cuts of pork, porchetta, fish, vegetables, even fruit.

The optional Vertical Spit System with its choice of eight hanging accessories expands the menu possibilities even more and adds additional visual appeal.

## FEATURES

- Energy efficient
- Tempered K-glass doors
- Independent motor for each spit
- Equipped with bottom drip tray with built-in drainage
- Rotisol patented burners
- Powerful halogen lamps
- Delivered with 8 prongless spits (CUI1675)
- Illuminated sign «Rotisserie» for enamel model only
- Base on casters with brakes









GF1675-8G-LUX

Black porcelain enamel and brass

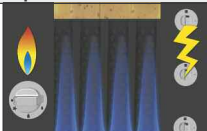
## TECHNICAL DETAILS

Overview of some of the standard features.

	Stainless steel burner with removable air filter (Rotisol patent)		Robust hinges designed for heavy use, with integrated locking in open and closed positions		Gas safety ! separation of the gas and electric chambers avoids any risks of explosion
	Gas and electric switches, in chromed or brass-colored metal		Anti-scald K-glass reduces external thermal radiation (energy saving). Glass overlaps drip pan to keep splatters inside (anti-slip protection).		Removable inside side-panels doubles protection from grease seeping into motors and other sensitive parts

## ACCESSORIES

A variety of accessories are available. See video of available accessories and of vertical spit system online.

<b>CUI1675</b> Anti-cutting prongless V-spit.		<b>BP1675</b> Chicken spit.		<b>BRC1675</b> Rectangular basket spit.	
<b>BS1675</b> Spit for ham / turkey.		<b>BRRO1675</b> Roast-clamp spit.		<b>BA1675</b> Lamb/suckling-pig spit.	
<b>BCR1675</b> Spatchcock chicken basket.		<b>DEC</b> Spit mover.		<b>BPOR1675</b> Porchetta spit.	

**Front view**  
Rotisserie with roof

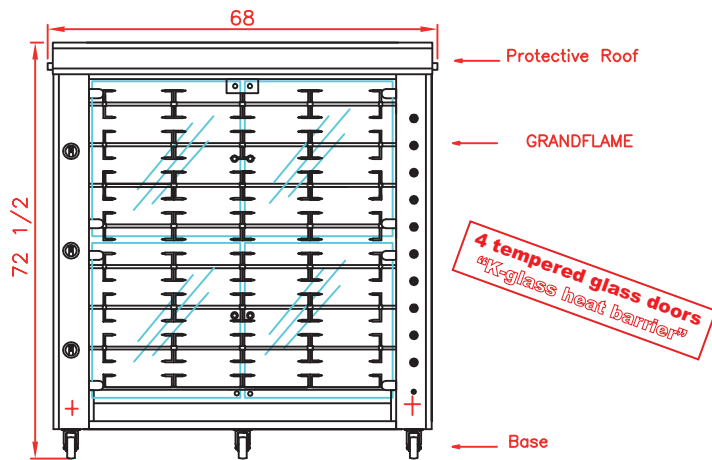

**Top view**  
Rotisserie with roof

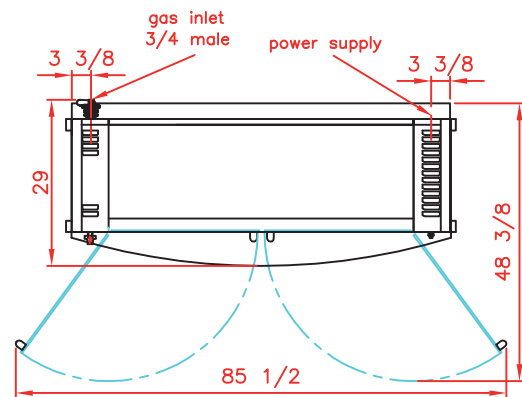

**Side view**  
Rotisserie with roof

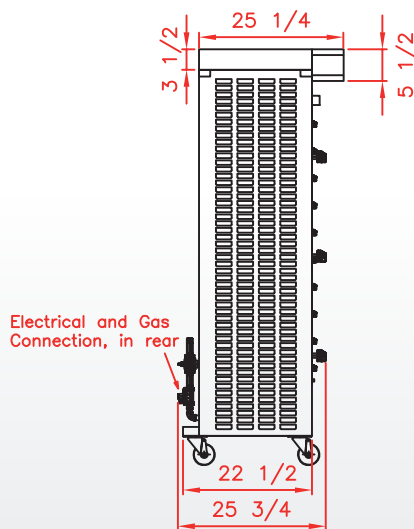

Revised :  
March 2018

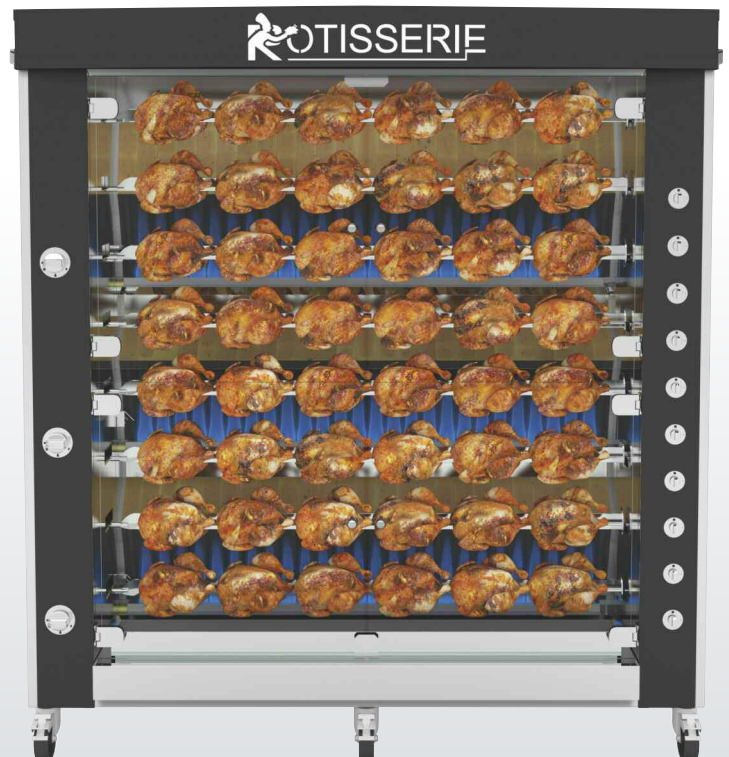

GF1675-8G-SSP  
Stainless steel with porcelain enamel

### SPECIFICATIONS

Capacity	56/64 chickens
Gas power	175000 BTU/h
Power supply	208-240V-60Hz ; 2,6 Amps
Electrical power	0,54 kW
Weight and size (HxDxW)	770 Lbs ; 72 1/2 x 29 x 68 inches
Shipping weight and size	907 Lbs ; 70 1/8 x 30 3/4 x 77 5/8 inches
Warranty	1 year parts and labor

**DISTRIBUTOR / AGENT**

Rotisol France, Inc.  
415 W. Walnut St. Gardena, CA 90248  
[info@rotisolusa.com](mailto:info@rotisolusa.com)  
Ph :310 671 7254  
Fax :310 671 8071