

### DESIGN

Rotisol's traditional rustic-style rotisserie, the MasterFlame, is an attractive show-piece for any restaurant or kitchen and is used by chefs in Michelin's star restaurants around the world.

The visible flames from Rotisol's patented burners spread up the porcelain wicks creating a spectacular visual that can be seen through the front and side glass doors.

Spits are driven by an elegant system of chains and pulleys, rotating at 2 ½ times per minute, ensuring perfectly cooked, self-basting poultry, meat, vegetables and fish.

The optional Vertical Spit System with its choice of eight hanging accessories expands the menu possibilities even more and adds additional visual appeal.

### FEATURES



- Rotisol patented burners
- Tempered K-glass front and side doors
- Decorative roof included
- Pre-installed vertical spit system
- Independent motor for each spit
- Equipped with bottom drip tray with built-in drainage
- Powerful halogen lamps
- Delivered with 4 prongless spits (CUI13)



### TECHNICAL DETAILS

Overview of some of the standard features.

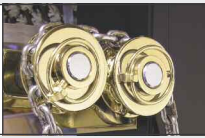
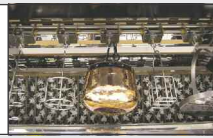
MF1375-4G-LUX  
Black porcelain enamel and brass

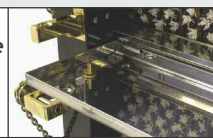
	Cast iron with ceramic wicks provides a magnificent display of flames		Visible rustic pulleys and drive chains for added front-of-house appeal		Pre-installed vertical spit system allows for vertical cooking
	Decorative terracotta firebricks absorb and radiate the heat		Gas knobs in brass or chrome finish allow fine tuning of the gas flow		Middle drip pan allows separation of products to prevent cross-contamination

### ACCESSORIES

A wide variety of accessories are available. Please consult us. See video of available accessories and of vertical spit system online.

<b>CUI13</b> Anti-cutting prongless V-spit.		<b>BP13</b> Chicken spit.		<b>BRC13</b> Rectangular basket spit.	
<b>BS13</b> Spit for ham / turkey.		<b>BRRO13</b> Roast-clamp spit.		<b>BA13</b> Lamb/suckling-pig spit.	
<b>BCR13</b> Spatchcock chicken basket.		<b>DEC</b> Spit mover.		<b>BPOR13</b> Porchetta spit.	

**Front view**  
Rotisserie with roof

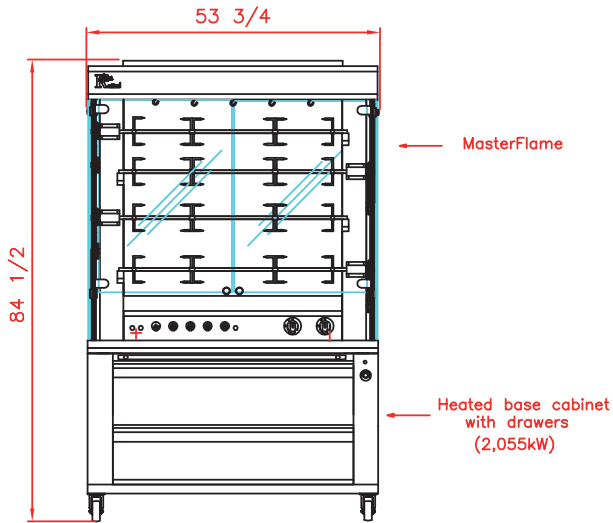

**Top view**  
Rotisserie with roof

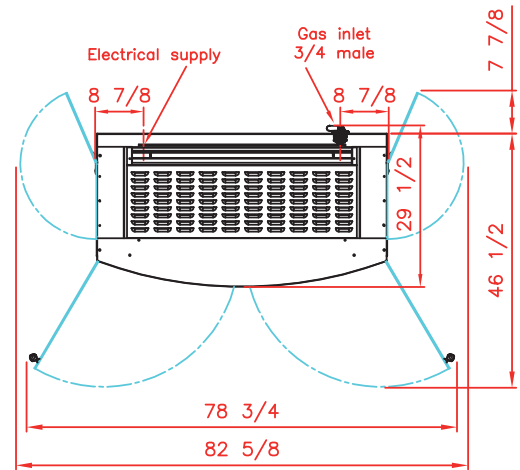

**Side view**  
Rotisserie with roof

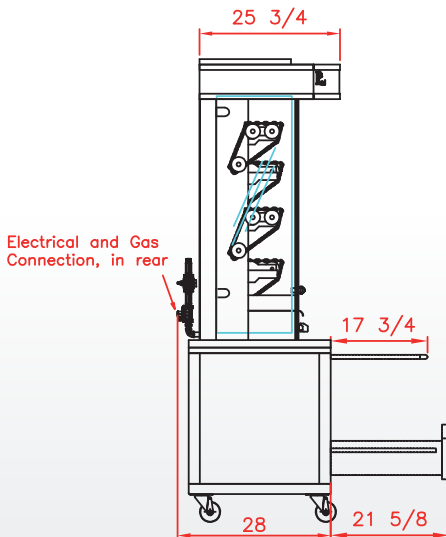

Revised :  
October 2020



MF1375-4G-LUX  
Black porcelain enamel with chrome

### SPECIFICATIONS

Capacity	20/24 chickens
Gas power	82000 BTU/h
Power supply	208-240V-60Hz ; 2,8 Amps
Electrical power	0,57 kW
Weight and size (HxDxW)	706 Lbs ; 84 1/2 x 29 1/2 x 53 3/4 inches
Shipping weight and size	818 Lbs ; 87 1/2 x 30 x 59 1/8 inches
Warranty	1 year parts and labor

**DISTRIBUTOR / AGENT**

Rotisol France, Inc.  
415 W. Walnut St. Gardena, CA 90248  
[info@rotisolusa.com](mailto:info@rotisolusa.com)  
Ph :310 671 7254  
Fax :310 671 8071