



# Rôti-Roaster

## FBPP16.520

### DESIGN

The new generation of "Rôti-Roaster" rotisseries allow professionals an optimal use with energy saving and respect for the environment as they are fully insulated. Highly technological but easy to use, they feature an automatic cooling of the heating turbines at the end of the cooking cycle. All accessories and inside panels are removable for ease of cleaning, while being reliable and meeting safety requirements.

Aware of the energy expense for its customers, Rotisol has implemented an energy saving program on its electrical products. Differences in consumption vary from 25 to 40% compared to competing products, for a faster and more economical performance.

### FEATURES

- Control panel with 6 cooking programs. Pre-heating, alarm at end of cooking cycle and temperature maintenance (+ 145° K).
- Anti-burns and anti-radiation K.GLASS glass for energy savings (accelerated cooking), mounted on a removable silicone joint.
- Options: curved anti-burn double glass.
- Removable drip pan with drainage tap.
- 2 lights protected by a ceramic glass (flat surface for easy cleaning).
- Removable planetary central axis.
- Delivered with 16 baskets (BALD520).
- Optional: Banner with illuminated "Rotisserie" sign, choice of epoxy finish or all stainless steel.



FBPP16.520  
(optional stand)



### TECHNICAL DETAILS

Overview of some of the standard features.

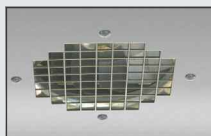

Heat diffused by turbine for a homogeneous distribution of the temperature in the cooking chamber.







Silicone gasket for sealing the door when closed.



6 cooking programs, alarm at end of cycle. Display and programming of cooking time and temperature.

### ACCESSORIES

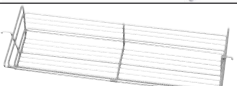
Many accessories are available. Videos of the [accessories](#).

|  |   |   |  |   |   |
|--|---|---|--|---|---|
| <p><b>BALD520</b><br/>Chicken baskets.</p>   |  | <p><b>BV520</b><br/>Chicken spit.</p>             |  | <p><b>BCRA520</b><br/>«Spatchcock chicken» baskets.</p> |  |
| <p><b>BAP520</b><br/>Small cuts baskets.</p> |  | <p><b>BAB520</b><br/>Big pieces of meat spit.</p> |  | <p><b>PD520</b><br/>Stainless steel rack top.</p>       |  |

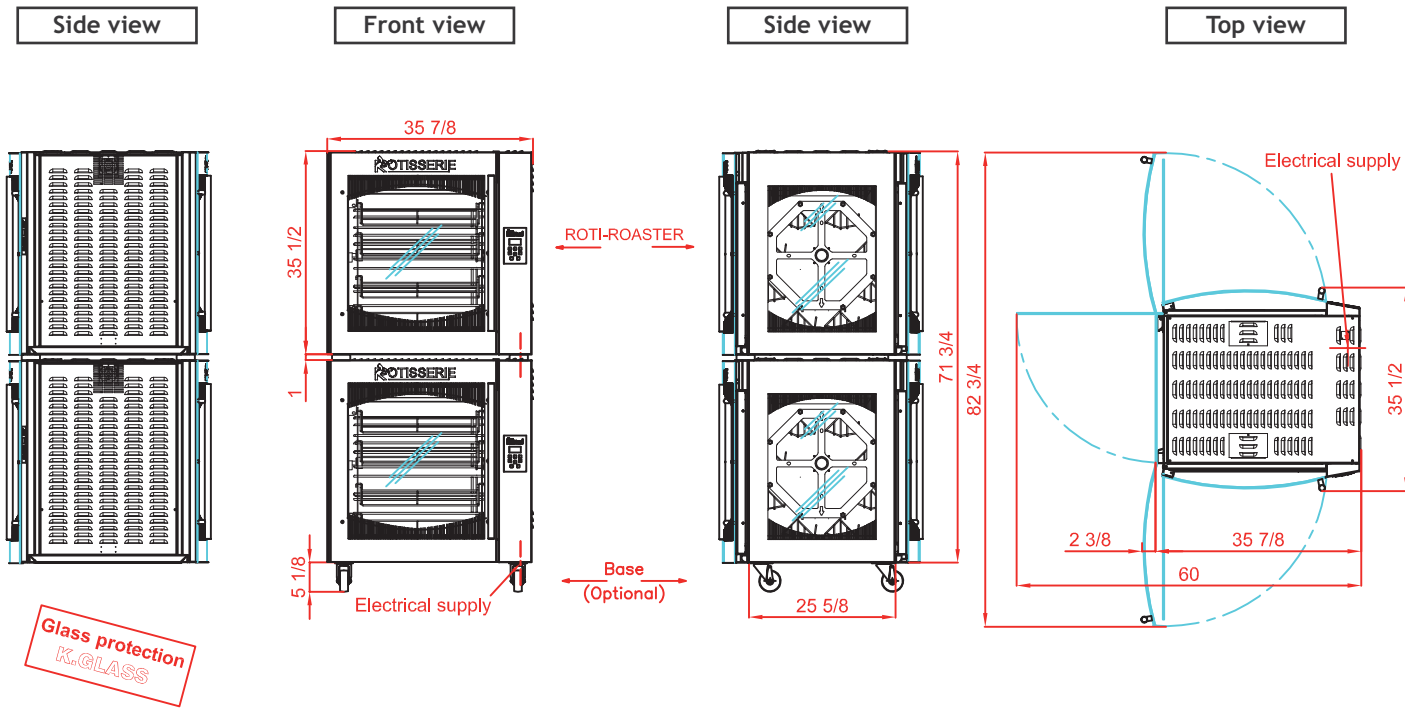

FBPP16.520  
(optional stand)



Revised :  
September 2020

## SPECIFICATIONS

|                              |  |
|------------------------------|--|
| Capacity roasted chickens    | 48/64 chickens, 16 baskets                 |
| Capacity spatchcock chickens | 40 chickens, 8 spatchcock chicken baskets  |
| Power supply - power         | 208-240V-60Hz ; 44 Amps ; 15,6 kW          |
| Weight and size (HxDxW)*     | 849 Lbs ; 76 7/8 x 36 1/4 x 35 7/8 inches  |
| Shipping weight and size*    | 1003 Lbs ; 82 3/4 x 40 5/8 x 43 3/8 inches |
| Warranty                     | 1 year parts and labor                     |

\* with a stand or base cabinet (optional)

DISTRIBUTOR / AGENT

Rotisol France, Inc.  
415 W. Walnut St. Gardena, CA 90248  
[info@rotisolusa.com](mailto:info@rotisolusa.com)  
Ph :310 671 7254  
Fax :310 671 8071

