



Rôti-Roaster

FBPP8.720

DESIGN

The new generation of "Rôti-Roaster" rotisseries allow professionals an optimal use with energy saving and respect for the environment as they are fully insulated. Highly technological but easy to use, they feature an automatic cooling of the heating turbines at the end of the cooking cycle. All accessories and inside panels are removable for ease of cleaning, while being reliable and meeting safety requirements.

Aware of the energy expense for its customers, Rotisol has implemented an energy saving program on its electrical products. Differences in consumption vary from 25 to 40% compared to competing products, for a faster and more economical performance.

FEATURES

- Control panel with 6 cooking programs. Pre-heating, alarm at end of cooking cycle and temperature maintenance (+ 145° K).
- Anti-burns and anti-radiation K.GLASS glass for energy savings (accelerated cooking), mounted on a removable silicone joint.
- Options: curved anti-burn double glass.
- Removable drip pan with drainage tap.
- 2 lights protected by a ceramic glass (flat surface for easy cleaning).
- Removable planetary central axis.
- Delivered with 8 baskets (BALD720).
- Optional: Banner with illuminated "Rotisserie" sign, choice of epoxy finish or all stainless steel.



FBPP8.720
(optional stand)



TECHNICAL DETAILS

Overview of some of the standard features.

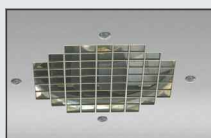

Heat diffused by turbine for a homogeneous distribution of the temperature in the cooking chamber.







Silicone gasket for sealing the door when closed.



6 cooking programs, alarm at end of cycle. Display and programming of cooking time and temperature.

ACCESSORIES

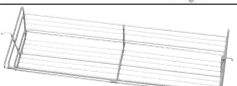
Many accessories are available. Videos of the [accessories](#).

<p>BALD720 Chicken baskets.</p>		<p>BV720 Chicken spit.</p>		<p>BCRA720 «Spatchcock chicken» baskets.</p>	
<p>BAP720 Small cuts baskets.</p>		<p>BAB720 Big pieces of meat spit.</p>		<p>PD720 Stainless steel rack top.</p>	

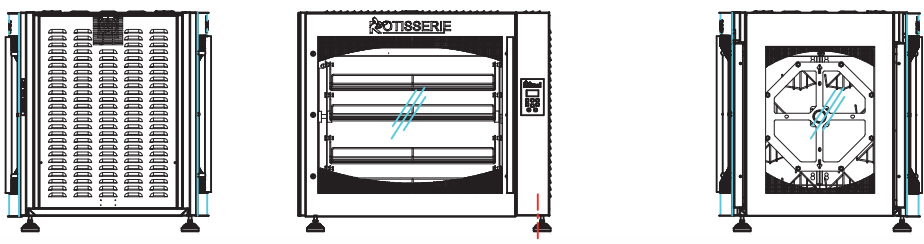
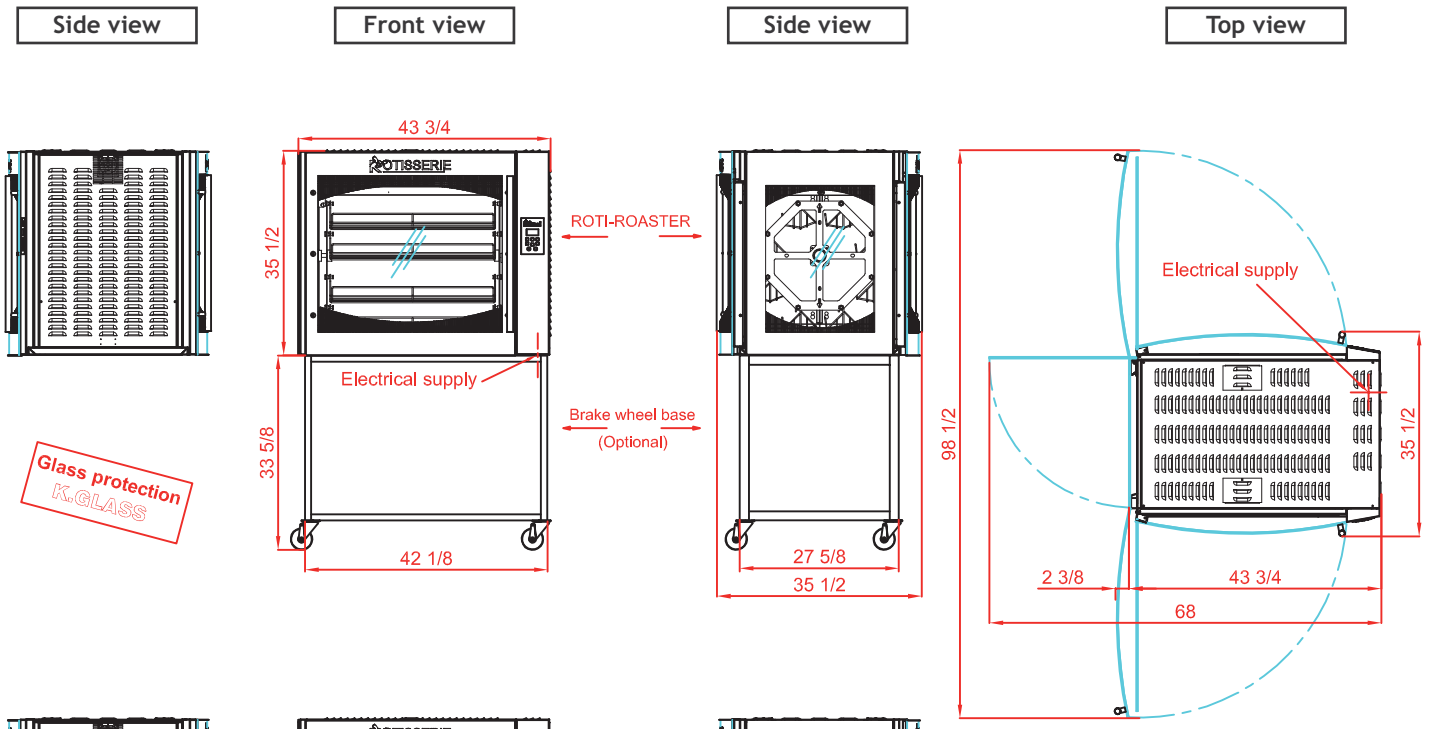

FBPP8.720
(optional stand)



Revised :
September 2020

SPECIFICATIONS

Capacity roasted chickens	32/40 chickens, 8 baskets
Capacity spatchcock chickens	28 chickens, 4 spatchcock chicken baskets
Power supply - power	208-240V-60Hz ; 27 Amps ; 9,5 kW
Weight and size (HxDxW)*	669 Lbs ; 76 7/8 x 36 1/4 x 44 inches
Shipping weight and size*	741 Lbs ; 82 3/4 x 40 5/8 x 48 1/2 inches
Warranty	1 year parts and labor

* with a stand or base cabinet (optional)

DISTRIBUTOR / AGENT

Rotisol France, Inc.
415 W. Walnut St. Gardena, CA 90248
info@rotisolusa.com
Ph :310 671 7254
Fax :310 671 8071

